

**Simple
Application
Controllers**

**ALPHA
ALPHA XL**

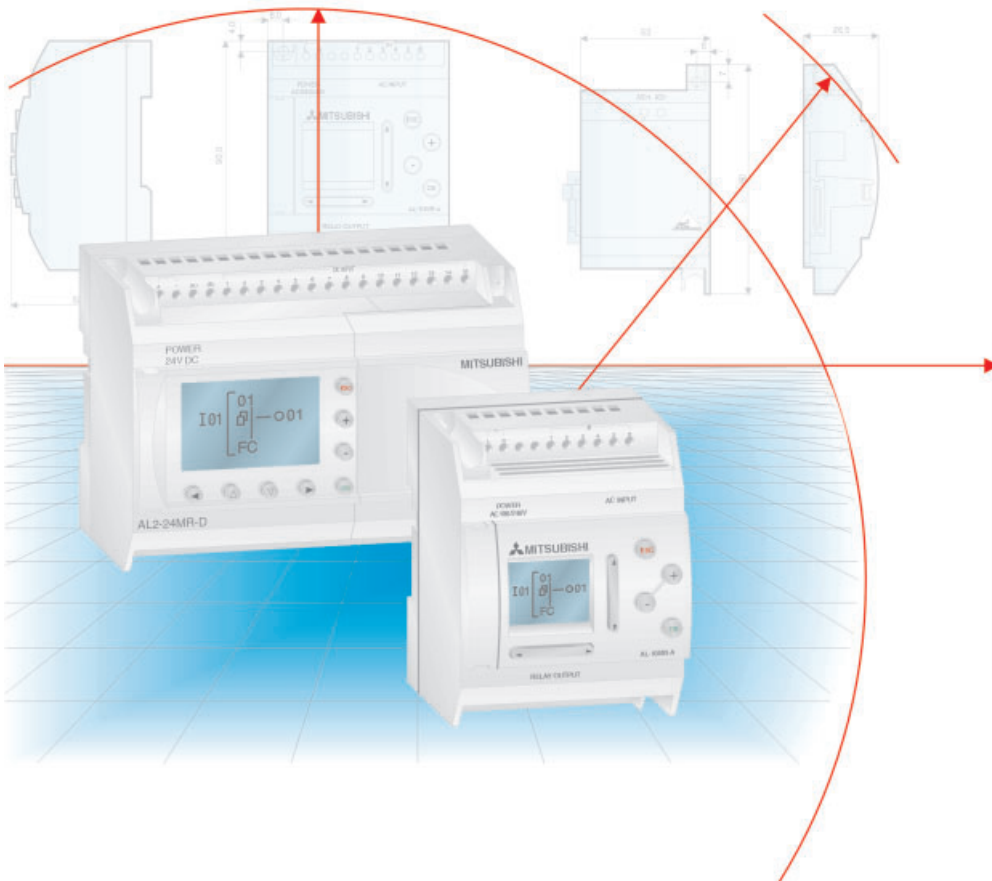
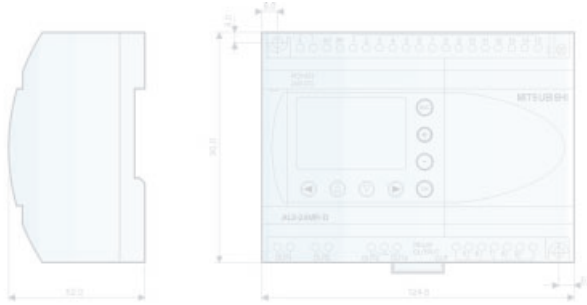

Technical Catalogue

2005

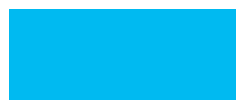

A controller concept pointing the way

New Products

Three new analog extension modules for the ALPHA XL are an addition to the digital extension modules already available.

The analog output module AL2-2DA converts a digital input value from the ALPHA XL to an analog output signal (voltage or current).

The temperature adaptors AL2PT-ADP and AL2TC-ADP are used to convert a temperature input, measured by external temperature sensors, to an analog output signal in the range from 0 to 10 V for use in the main unit.

Further publications within the PLC range

Technical Catalogues

Technical Catalogues MELSEC PLC

Product catalogues for programmable logic controllers and accessories for the further MELSEC PLC series

Technical Catalogue HMI

Product catalogue for operator terminals, supervision software and accessories (art.no.68542)

Technical Catalogue Networks

Product catalogue for Master and Slave modules as well as accessories for the use of programmable logic controllers in open and MELSEC networks (art. no. 136730)

Technical Catalogues Drives

Product catalogues for frequency inverters, servo amplifiers, motion controllers and servo motors as well as the appropriate programming software and accessories

Additional Services

You will find current information on updates, alterations, new items, and technical support on the MITSUBISHI ELECTRIC's web pages (www.mitsubishi-automation.com). The products section of the MITSUBISHI home site includes various documentations of the whole product range by MITSUBISHI ELECTRIC as well as the current version of this catalogue on hand. All manuals and catalogues can be downloaded. The content is updated daily and to date is provided in German and English.

About this product catalogue

Due to the constantly growing product range, technical alteration, and new or changed characteristic features, this catalogue is updated frequently.

Texts, figures and diagrams shown in this product catalogue are intended exclusively for explanation and assistance in planning and ordering the programmable logic controllers of the ALPHA series and the associated accessories. Only the manuals supplied with the modules are relevant for installation, commissioning and handling of the controllers and the accessories. The information given in this documentation must be read before installation and commissioning of the modules.

Should questions arise with regard to the planning of modules described in this product catalogue, do not hesitate to contact the german branch of the MITSUBISHI ELECTRIC EUROPE B.V. in Ratingen or one of its distributors (see cover page).

© MITSUBISHI ELECTRIC EUROPE B.V. 04/2005 (5th edition - version E)

ALPHA

BASIC COMPONENTS

- ◆ System description 4
- ◆ Description of units..... 6
- ◆ Specifications 8

EXTENSIONS

- ◆ Extension modules for additional inputs/outputs 12
- ◆ Analog extension modules 13
- ◆ AS Interface module..... 14

ACCESSORIES

- ◆ EEPROM cassettes, mounting frames, simulation box 16
- ◆ PC cable, GSM cable, power supply 17

TERMINAL ASSIGNMENT + DIMENSIONS

- ◆ Terminal assignment 18
- ◆ Dimensions 20

SOFTWARE

- ◆ Programming software 22
- ◆ Description of function blocks 24

APPENDIX

- ◆ Order form..... 26
- ◆ Index 27

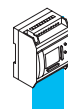

The ALPHA Series

Description

- Compact
- Self-sufficient
- Cost effective
- Versatile

The new ALPHA closes the present gap between single components and a PLC system. It combines all advantages of a PLC system in a very compact housing and therefore provides a room and cost saving alternative to relays and contactors. Up to 64 functions (or 1.5 kB data) can be processed by a program. Each of the available functions (timers, counters, analog processing, calender/clock function etc.) can be used in all programs as frequently as needed.

Benefits

- Master controller with complete PLC functions
- Integrated power supply unit
- CPU
- Maintenance-free EEPROM memory
- Integrated inputs and outputs
- Analog signal processing for up to 8 configurable analog inputs (controllers with 24 V DC supply)
- Direct programming via the integrated control panel with graphical LCD display
- Control panel can be used as simple operator terminal (HMI)
- Comfortable calender/clock function
- Serial interface for external communications with a PC
- User-friendly programming software AL-PCS/WIN for comprehensive and structured programming under MS Windows 95/98/NT
- Connectable to the AS-Interface field bus via extension module (ALPHA 20 only)

Features

The master controllers are available in different variations regarding the power supply and the kind of outputs. Controllers for a 230 V AC or 24 V DC power supply and with relay or transistor outputs are supplied. All units feature the same CPU and the same characteristics. The ALPHA 20 can additionally be extended by a plug-in module for AS Interface network connection as a slave module.

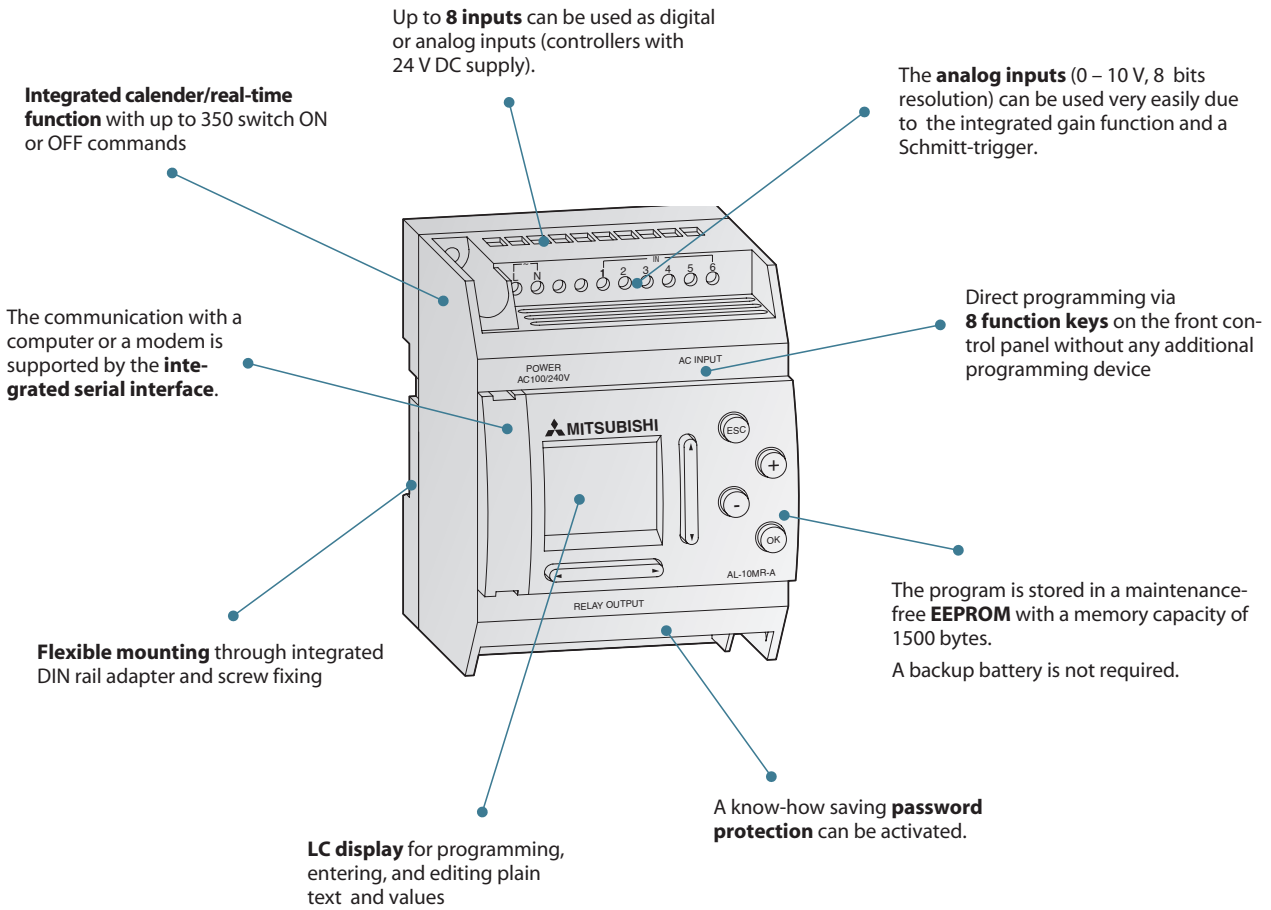
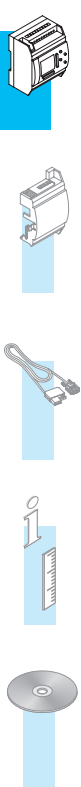

The ALPHA XL Series

Description

The new ALPHA XL comes into its own where the existing products of the ALPHA series run up against their limitations. With many powerful new features it is predestined for applications on industrial machines and apparatus and in building automation services.

Key enhancements in the ALPHA XL include a tripling of program capacity to 200 function blocks, an extra-large display, expansion options and a second communications port. Fifteen new function blocks have been added to the instruction set, including math operations, PWM and SMS text messaging functions. All this opens up new possibilities for analog signal processing, for example in temperature control applications.

Benefits

As an addition to the extraordinary features of the ALPHA series the ALPHA XL offers further innovations:

- Extra-big backlit LCD display
- Tripled program capacity with subtotal 200 function blocks
- 15 new user program blocks
- New display functions with integrated HMI functionality
- 8 Integrated analog inputs and 2 high-speed counters
- Integrated second communications port
- Remote maintenance and SMS text messaging via GSM cable
- Peripheral connection via RS-232C
- Significantly extended operating temperature range
- Extensive clock functions
- AS-I slave module connectable
- Extension modules for digital inputs and outputs

Features

User-friendly operation and a highly legible display are two more strong points of the ALPHA XL. The extra-large, backlit information screen features new display options such as bar graphs and moving text displays.

Three-level password protection reliably prevents unauthorised access to editable process data and parameters, which can be changed directly via eight function keys.

The operating temperature range has been extended to -25 – +55°C, making the unit suitable for outdoor (e.g. special vehicles) and refrigeration applications with the same precision and reliability.

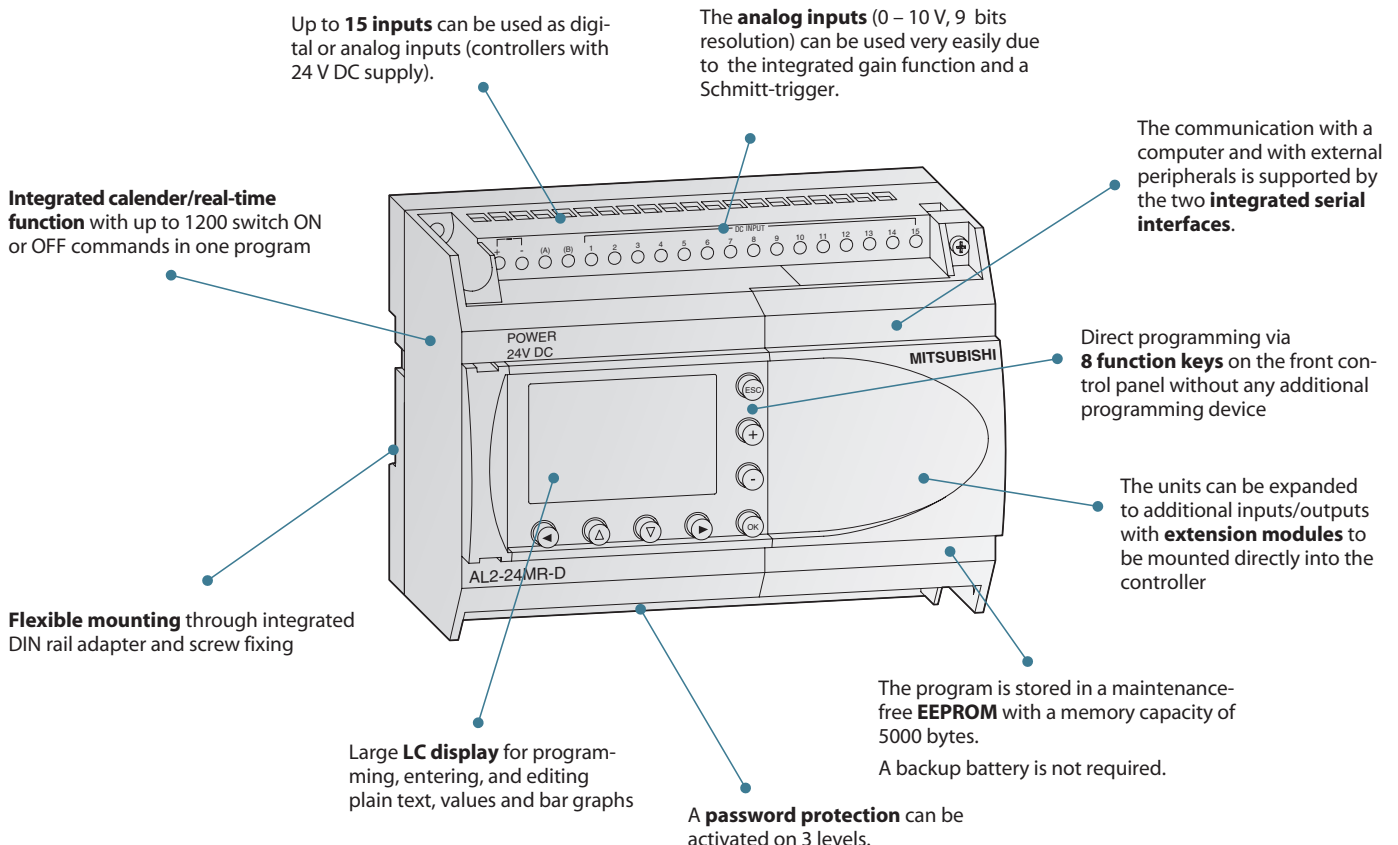
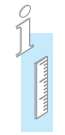
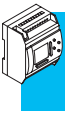

Description of the Module Components ALPHA

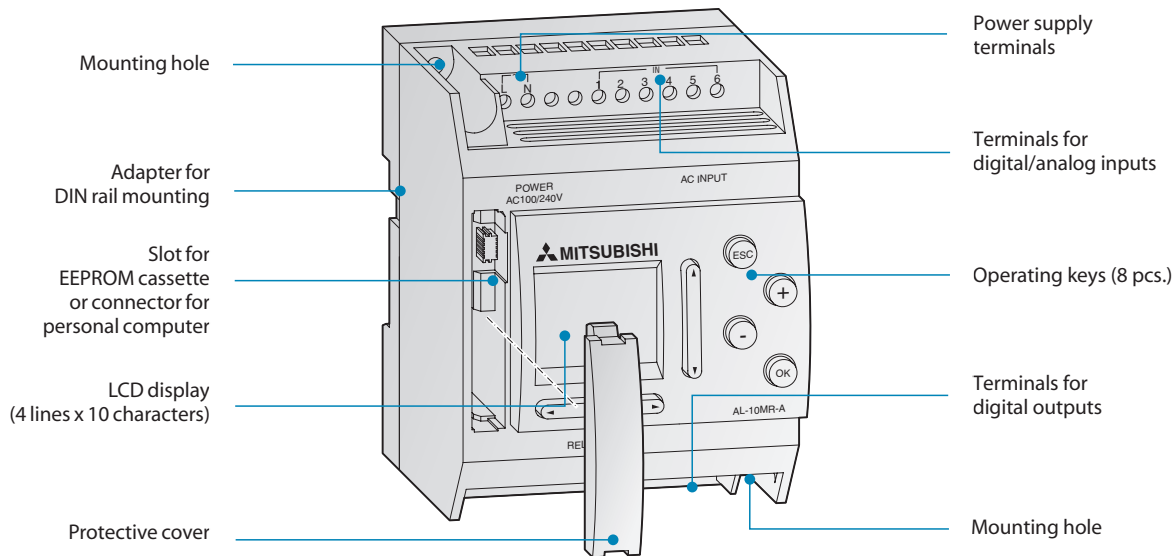

Description of the Module Components ALPHA XL

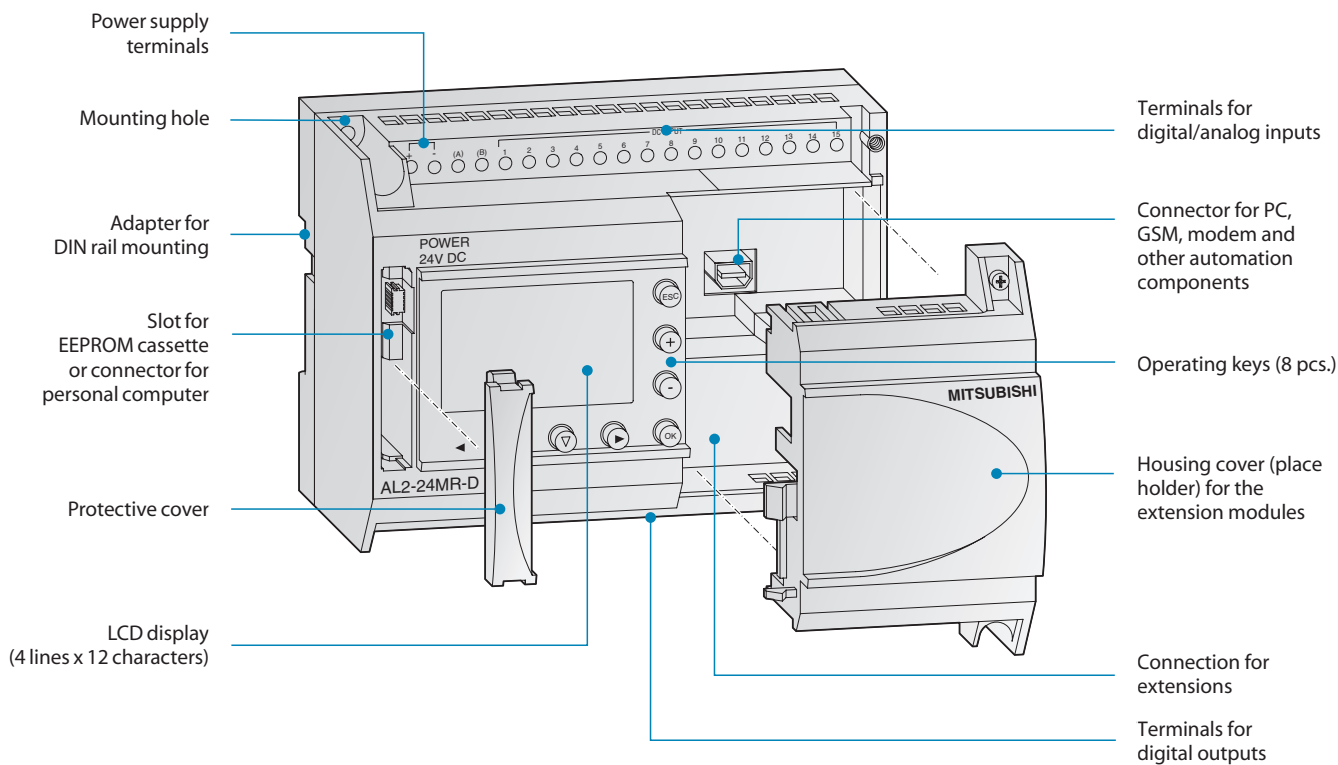

Expansion Capabilities

The ALPHA XL is equipped with a second communications interface. This allows communications with other automation components.

Also there is the possibility to carry out remote maintenance via a GSM modem. Additionally it is possible to send SMS text

messages to a mobile telephone, e-mails to a personal computer and even faxes.

The integration into an AS interface network is achieved with the help of an AS-Interface module.

Extension modules are available for additional inputs and outputs allowing for an extension of up to 4 inputs or outputs and 2 analog outputs.

Mounting frames simplify the assembly and also protect the controller in hostile environments.

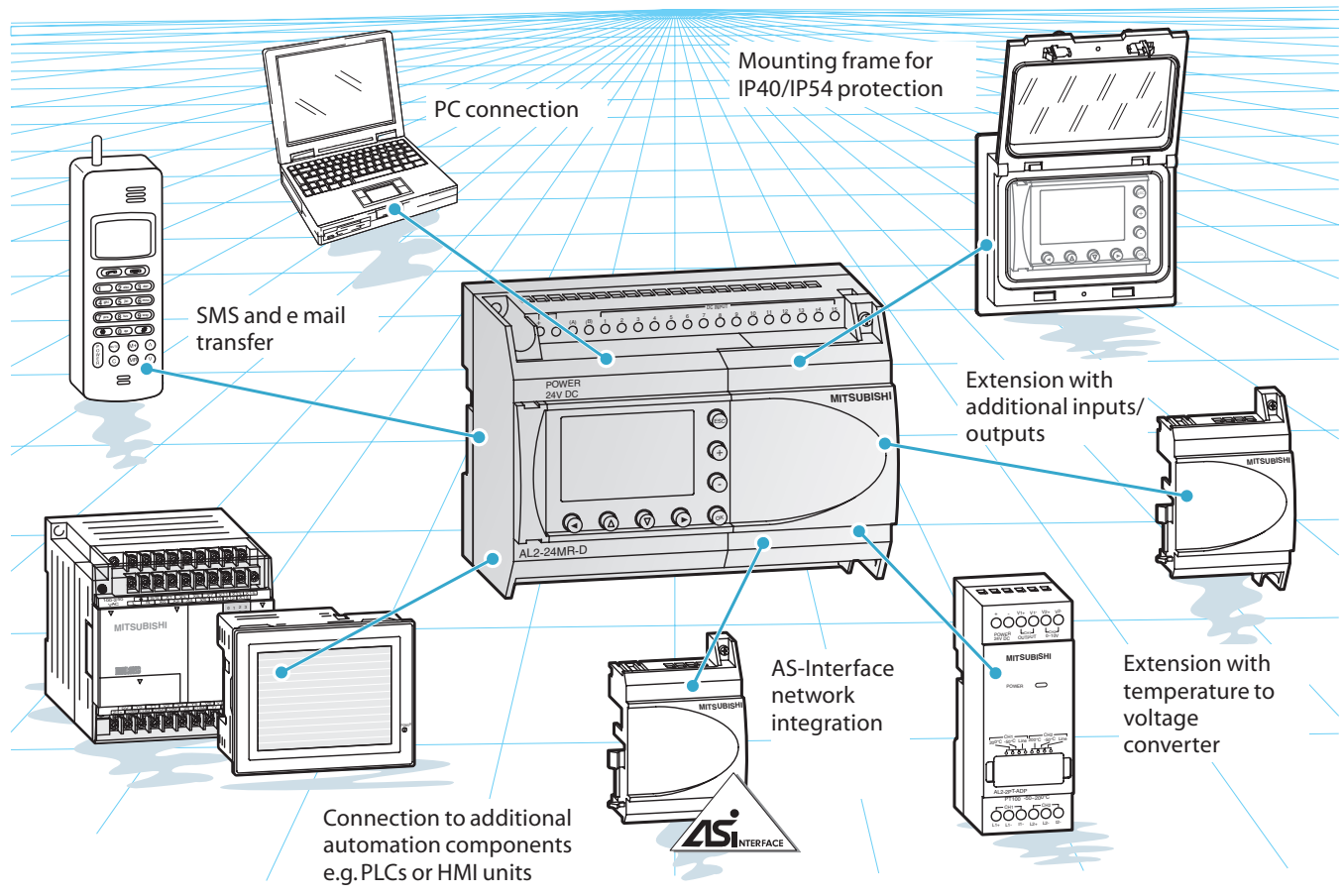

Reference for Model Designation Code

AL	-	10	M	R	-	A
1	2	3	4	5		

The code explanation in detail:

- 1 Designation of the ALPHA series
AL = ALPHA
AL2 = ALPHA XL
- 2 Number of inputs/outputs e.g. 10 I/Os
- 3 Designation of the module:
M = Master controller
- 4 Designation of the output type:
R = Relay
T = Transistor
- 5 Designation of the power supply:
A = 100/240 V AC
D = 24 V DC

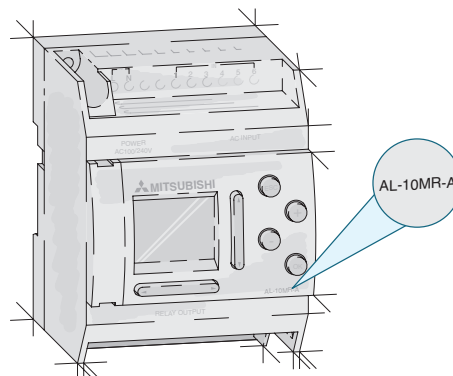

Specifications ALPHA

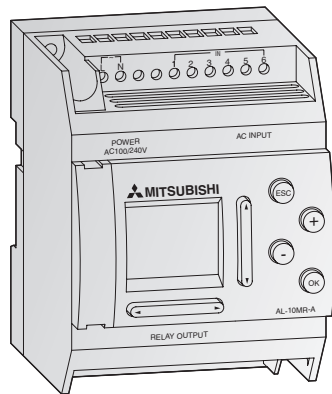

AL-6M□□, AL-10M□□

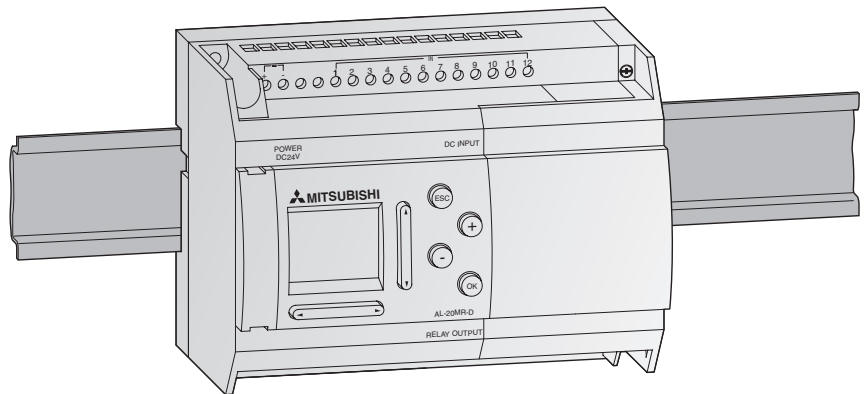

AL-20M□□

Specifications		AL-6MR-A	AL-10MR-A	AL-10MR-D	AL-10MT-D	AL-20MR-A	AL-20MR-D	AL-20MT-D
Electrical specifications								
Integrated inputs/outputs		6	10	10	10	20	20	20
Power supply	AC range (+10%, -15%)	100–240 V AC	100–240 V AC	24 V DC	24 V DC	100–240 V AC	24 V DC	24 V DC
	Frequency at AC	Hz 50–60 Hz	50–60 Hz	—	—	50–60 Hz	—	—
	Voltage fluctuation	-15 – +10 %	-15 – +10 %	-15 – +20 %	-15 – +20 %	-15 – +10 %	-15 – +20 %	-15 – +20 %
Max. permissible voltage drop time	ms	10	10	5	5	10	5	5
Max. power consumption	W	3	4	3	2	8	7	5
Typ. power consumption	All I/Os ON	W 2.5	3.0	2.0	2.0	5.0	5.0	5.0
	All I/Os OFF	W 1.5	1.5	0.3	0.3	1.5	0.3	0.3
Inrush current		≤1.5 (at 240 V AC)	≤1.5 (at 240 V AC)	≤7.0 (at 24 V DC)	≤7.0 (at 24 V DC)	≤1.5 (at 240 V AC)	≤7.0 (at 24 V DC)	≤7.0 (at 24 V DC)
Digital inputs								
Integrated inputs	number	4	6	6	6	12	12	12
Input voltage		100–240 V AC	100–240 V AC	24 V DC	24 V DC	100–240 V AC	24 V DC	24 V DC
Input current		0.24 mA at 240 V	0.24 mA at 240 V	5.0 mA at 24 V	5.0 mA at 24 V	0.24 mA at 240 V	5.0 mA at 24 V	5.0 mA at 24 V
Response time	ms	50	50	10–40	10–40	50	10–40	10–40
Input frequency	Hz	5	5	20	20	5	20	20
Analog inputs								
Channels		—	—	6	6	—	8	8
Analog input range		—	—	0–250	0–250	—	0–250	0–250
Resolution		—	—	10000/250 mV	10000/250 mV	—	10000/250 mV	10000/250 mV
Conversion speed	ms	—	—	10	10	—	10	10
Voltage		—	—	0–10 V DC	0–10 V DC	—	0–10 V DC	0–10 V DC
Impedance		—	—	< 150 kΩ	< 150 kΩ	—	< 150 kΩ	< 150 kΩ
Accuracy		—	—	±5 % (0.5 V DC)	±5 % (0.5 V DC)	—	±5 % (0.5 V DC)	±5 % (0.5 V DC)
Outputs								
Integrated outputs	number	2	4	4	4	8	8	8
Type		Relay	Relay	Relay	Transistor	Relay	Relay	Transistor
Switched voltage (max.)	V	250 V AC, 30 V DC	250 V AC, 30 V DC	250 V AC, 30 V DC	5–24 V DC	250 V AC, 30 V DC	250 V AC, 30 V DC	5–24 V DC
Rated current	A	8	8	8	1 (at 8–24 V DC), 0.1 (at 5–8 V DC)	8	8	1 (at 8–24 V DC), 0.1 (at 5–8 V DC)
Max. switched load	- inductive load	—	—	—	1 A / 24 V DC	—	—	1 A / 24 V DC
	- resistive load	—	—	—	3 W / 24 V DC	—	—	3 W / 24 V DC
Minimum load		50 mW	50 mW	50 mW	1.0 mA	50 mW	50 mW	1.0 mA
Response time	ms	≤10	≤10	≤10	≤1	≤10	≤10	≤1
Leakage current		—	—	—	≤0.1 mA / 24 V DC	—	—	≤0.1 mA / 24 V DC
Relay contact lifetime cycles		100000 (at 8 A)	100000 (at 8 A)	100000 (at 8 A)	—	100000 (at 8 A)	100000 (at 8 A)	—
Mechanical specifications								
Weight	kg	0.2	0.2	0.2	0.2	0.32	0.32	0.32
Dimensions (W x H x D)	mm	71.2 x 90 x 55	71.2 x 90 x 55	71.2 x 90 x 55	71.2 x 90 x 55	124.6 x 90 x 55	124.6 x 90 x 55	124.6 x 90 x 55
Order information	Art. no.	87659	140190	140191	140192	140193	140194	140195
Accessory		Power supply ALPHA POWER 24-1.5 for DIN rail mounting, for DC supply of all 24 V DC modules; art. no.: 149046						

Specifications ALPHA XL

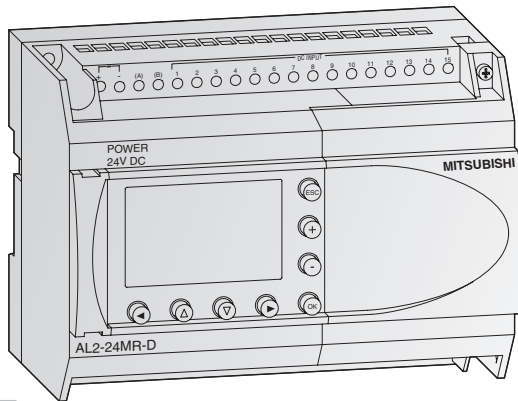

AL2-24MR-D

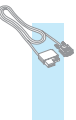
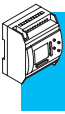

Specifications		AL2-14MR-A	AL2-14MR-D	AL2-24MR-A	AL2-24MR-D
Electrical specifications					
Integrated inputs/outputs		14	14	24	24
Power supply	AC range (+10%, -15%)	100–240 V AC	24 V DC	100–240 V AC	24 V DC
	Frequency at AC	50–60 Hz	—	50–60 Hz	—
	Voltage fluctuation	-15 – +10 %	-15 – +20 %	-15 – +10 %	-15 – +20 %
Max. permissible voltage drop time		ms 10	5	10	5
Max. power consumption		W 5.5	7.5	7.0	9.0
Typ. power consumption	All I/Os ON	W 4.5	4.0	5.5	5.0
	All I/Os OFF	W 2.0	1.0	2.5	1.0
Inrush current		≤6.5 A (at 240 V AC)	≤7.0 A (at 24 V DC)	≤6.5 A (at 240 V AC)	≤7.0 A (at 24 V DC)
Digital inputs					
Integrated inputs		number 8	8	15	15
Input voltage		100–240 V AC	24 V DC	100–240 V AC	24 V DC
Input current		0.24 mA at 240 V	5.0 mA at 24 V	0.24 mA at 240 V	5.0 mA at 24 V
Response time		ms 50	10 – 20	50	10 – 20
Input frequency		Hz 5	20	5	20
Analog inputs					
Channels		—	8	—	8
Analog input range		—	0–500	—	0–500
Resolution		—	9 bit, 20 mV (10 V, 500)	—	9 bit, 20 mV (10 V, 500)
Conversion speed		ms —	8	—	8
Voltage		—	0–10 V DC	—	0–10 V DC
Impedance		kΩ —	142 ±5 %	—	142 ±5 %
Accuracy		—	±5 % (0.5 V DC)	—	±5 % (0.5 V DC)
Outputs					
Integrated outputs		number 6	6	9	9
Type		Relay	Relay	Relay	Relay
Switched voltage (max.)		V 250 V AC, 30 V DC	250 V AC, 30 V DC	250 V AC, 30 V DC	250 V AC, 30 V DC
Rated current		A 8	8	8	8
Max. switched load	- inductive load	373 VA (at 250 V)	373 VA (at 250 V)	373 VA (001–004), 93 VA (005–009)	373 VA (001–004), 93 VA (005–009)
	- resistive load	—	—	—	—
Minimum load		50 mW	50 mW	50 mW	50 mW
Response time		ms ≤10	≤10	≤10	≤10
Leakage current		—	—	—	—
Relay contact lifetime cycles		100000 (at 8 A)	100000 (at 8 A)	100000 (at 8 A)	100000 (at 8 A)
Mechanical specifications					
Weight		kg 0.3	0.3	0.35	0.3
Dimensions (W x H x D)		mm 124.6 x 90 x 52	124.6 x 90 x 52	124.6 x 90 x 52	124.6 x 90 x 52
Order information		Art. no. 152522	152523	152524	152525
Accessory		Power supply ALPHA POWER 24-1.5 for DIN rail mounting, for DC supply of all 24 V DC modules; art. no.: 149046			

General Operating Conditions

Operating conditions	Alpha series	Alpha XL series
Ambient temperature	0 – 55 °C	Display: -10 – 55 °C, Hardware: -25 – 55 °C
Operating temperature	0 – 55 °C	Display: -10 – 55 °C, Hardware: -25 – 55 °C
Storage temperature	-30 – +70 °C	-30 – +70 °C
Protection rating	IP 20	IP 20
Noise immunity	1000 Vpp with noise generator; 1 µs at 30 – 100 Hz, tested by noise simulator	
Dielectric withstand voltage	3750 V AC, >1 min. according to EN60730	3750 V AC, >1 min. according to EN60730
Allowable relative humidity	35 – 85 % (no condensation)	
Shok resistance	Acc. to IEC 68-2-27: 147 m/s ² acceleration, 11 ms 3 x 3 directions	
Vibration resistance	direct mounting	Acc. to IEC-2-6: 147 m/s ² acceleration, 80 min. in each direction
	DIN rail mounting	Acc. to IEC-2-6: 9.8 m/s ² acceleration, 80 min. in each direction
Insulation resistance	500 V DC, 7 MΩ acc. to EN60730-1	
Grounding	None	
Ambient conditions	No corrosive gases, no dust	
Approvals	CE, UL/cUL, DNV	CE, UL/cUL, DNV
Tests	UL 508, EN60730-1, EN61010, EN50081-1, EN50082-1, EN50082-2	UL 508, EN60730-1, EN61010, EN50081-1, EN50082-1, EN50082-2

General System and Programming Specifications

System specifications	Alpha series	Alpha XL series
Programm specifications		
Programming method	Function block	Function block
Program capacity	64 function blocks or 1500 bytes (internally)	200 function blocks or 5000 bytes
Programm processing	Cyclic processing of the stored program	
Number of available instructions	23 different function blocks (see page 22)	38 different function blocks (see page 22)
Programm storage	Integrated EEPROM and optional additional EEPROM cassette	
Data storage	At voltage loss the current status of values, running time meters, and real-time data are stored for up to 20 days (at temperatures of 0 to 25 °C) through integrated capacitors	
Processing time	1 ms + 20 µs / log. instruction (complex commands 500 µs / instruction)	
Real-time clock	Seconds, minutes, hours, day of week, month, year (4-digit); accuracy: 5 s / day; automatic summer and winter time toggling	
Program protection	Via program	Program and keys (3 levels)

Control Terminal Functions

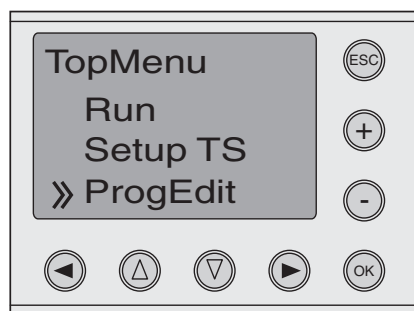

The ALPHA controllers can be completely programmed directly via the control terminal without any additional devices. 8 operating keys and a LC display (4 lines x 10 characters for the ALPHA and 4 lines x 12 characters for the ALPHA XL) are provided for this purpose.

The menus can be displayed in 6 different languages (german, english, french, italian, spanish and swedish).

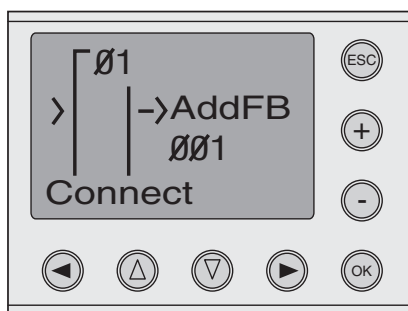

The LC display is user-programmable so that besides ALPHA internal values as well as plain text messages (and bar graphs at the ALPHA XL) can be displayed.

Displayed values of counters, timers, or running time meters can be edited directly via the 8 keys on the controller. Moreover, the keys are user-programmable similar to bits.

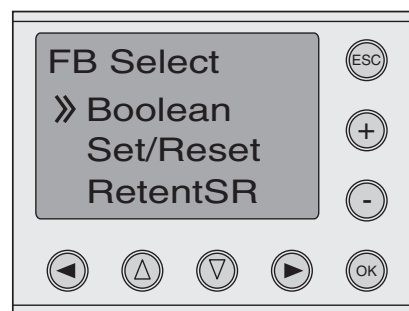

For the representation of function blocks all information is available on the display at the same time.

Communication with a Personal Computer

All ALPHA controllers can be programmed and monitored not only with the built-in operating keys but also easily via a connected personal or notebook computer.

In this case the powerful software AL-PCS/WIN is used (please refer to page 22). The connection between the ALPHA controller and the PC is made by the cable AL-232CAB (see page 17).

For remote monitoring, a (GSM) modem can be connected to the ALPHA XL (see page 17).

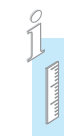
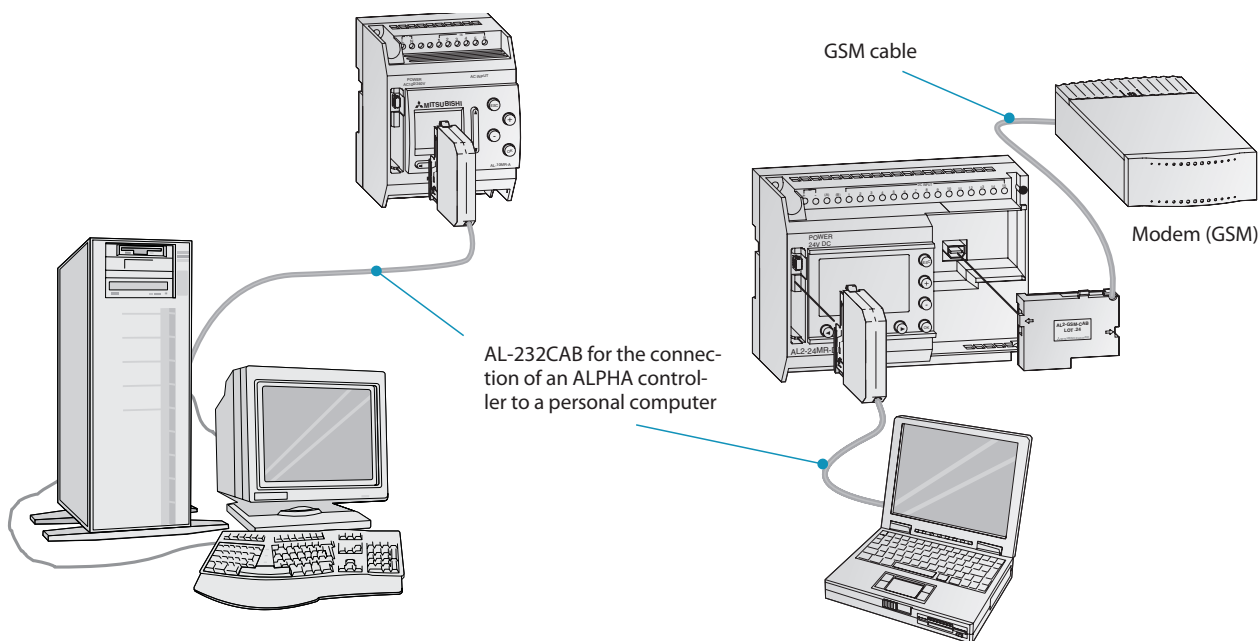

Digital Extension Modules

ALPHA ALPHA XL

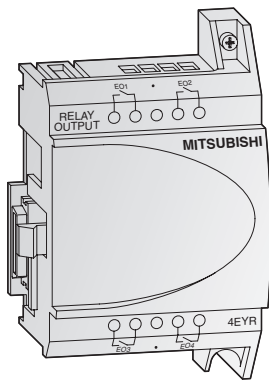

There are 4 different extension modules available for the ALPHA XL, which allow the controller to be extended through additional inputs or outputs. The modules are inserted directly into the ALPHA XL and therefore do not take up any additional space. The AL2-4EX has the additional feature that 2 inputs may be used as high-speed counters with a counting frequency of 1 kHz.

Specifications	AL2-4EX-A2	AL2-4EX	AL2-4EYR	AL2-4EYT
Electrical specifications				
Integrated inputs/outputs	4	4	4	4
Power Supply	AC range (+10 %, -15 %)	220–240 V AC	24 V DC	100–240 V AC
	Frequency at AC	50–60 Hz	—	50–60 Hz
	Voltage fluctuation	-15 – +10 %	-15 – +20 %	-15 – +10 %
Inputs				
Integrated inputs	number 4	4	—	—
Input voltage	220–240 V AC	24 V DC	—	—
Input current	7.5 mA at 240 V AC (50 Hz), 9.0 mA at 240 V AC (60 Hz)	5.4 mA at 24 V DC	—	—
Response time	ms 15 – 40	10 – 20*	—	—
Insulation	Photocoupler	Photocoupler	—	—
Input resistance	32 k Ω (50 Hz), 27 k Ω (60 Hz)	—	—	—
Outputs				
Integrated outputs	number —	—	4	4
Output type	—	—	Relay	Transistor
Switched voltage (max.)	V —	—	250 V AC, 30 V DC	5–24 V DC
Rated current	A —	—	2 A per output	1 A per output
Max. switched load	- inductive load	—	93 VA (at 250 V AC)	24 W (1 A, 24 V DC)
	- resistive load	—	—	3 W at 24 V DC
Minimum load	—	—	50 mW	1.0 A
Response time	ms —	—	≤ 10	≤ 1
Leakage current	—	—	—	≤ 0.1 mA, 24 V DC
Relay contact lifetime cycles	—	—	100000	—
Insulation	—	—	Photocoupler	Photocoupler
Mechanical specifications				
Weight	kg 0.05	0.05	0.05	0.05
Dimensions (W x H x D)	mm 53.1 x 90 x 24.5	53.1 x 90 x 24.5	53.1 x 90 x 24.5	53.1 x 90 x 24.5
Order information				
Art. no.	142522	142521	142523	142524

* EI1 and EI2 of the AL2-4EX can be used as high-speed counter inputs. In each case the response time for the high-speed counter inputs will be 0.5 ms or less.

Analog Extension Modules

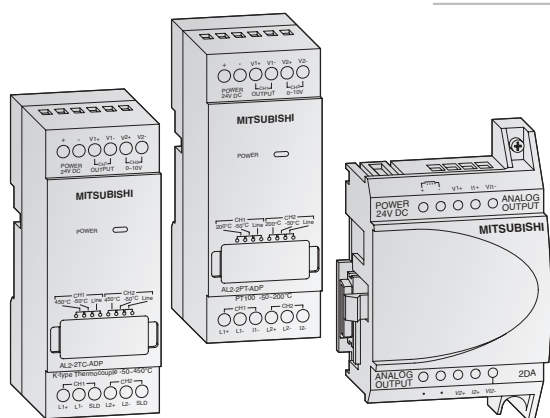
 ALPHA ALPHA XL

The analog extension modules enlarge the range of applications for the ALPHA XL widely. With these modules it is possible to give out voltage or current signals or to measure temperatures.

Three different analog extension modules are available:

The AL2-2DA offers two additional analog outputs for the ALPHA XL and converts a digital input value into a voltage or a current. This module is inserted directly into the ALPHA XL.

The AL2-2PT-ADP and the AL2-2TC-ADP are adaptors used for temperature measurement. The difference is in the type of temperature sensors used.

Platinum temperature sensors (Pt100) are connected to the AL2-2PT-ADP and to the thermocouple sensors (K type) are connected to the AL2-2TC-ADP. In both cases the temperature is converted to an analog signal in the range from 0 to 10 V. This voltage is measured by the analog inputs of the ALPHA XL. The temperature adaptors are mounted outside the ALPHA XL.

Specifications	AL2-2DA	AL2-2PT-ADP	AL2-2TC-ADP
Electrical specifications			
Number of channels	2	2	2
Power Supply	Voltage, current	24 V DC, 70 mA	24 V DC, 120 mA
	Voltage fluctuation	-15 – +10 %	-15 – +20 %
Analog inputs			
Integrated inputs	number	—	2
Connectable temperature sensors	—	PT100 sensor Temp. coefficient 3.850 ppm/°C (IEC 751)	Thermocouple (K type), isolated typ (IEC 584-1 1977, IEC 584-2 1982)
Compensated range	—	-50 – +200 °C	-50 – +450 °C
Overall accuracy	—	±1.5 %	±2.0 %
Resolution	—	0.5 °C	1 °C
Conversion time	ms	20.5	20.5
Isolation	—	No isolation between channels	No isolation between channels
Analog outputs			
Integrated outputs	number	2	—
Analog output range	Voltage	0 – 10 V DC (5 kΩ – 1 MΩ)	—
	Current	4 – 20 mA (max. 500 Ω)	—
Digital input	For voltage output	0 – 4000	—
	For current output	0 – 2000	—
Resolution	Voltage	2.5 mV (10 V / 4000)	—
	Current	8 mA	—
Overall accuracy	—	±1 %	—
D/A Conversion time	ms	20	—
Isolation	—	Photocoupler	—
Mechanical specifications			
Weight	kg	0.05	0.07
Dimensions (W x H x D)	mm	53.1 x 90 x 24.5	35.5 x 90 x 31
Order information			
Art. no.	151235	151238	151239

The Network with Actuator Sensor Interface

Data transfer

The AS interface is an international standard for the lowest field bus level. The network suits versatile demands, is very flexible and particularly easy to install.

The following parts are controlled:

- Sensors
- Actuators
- I/O units
- Gateways

Structure

ASI networks can be configured in any random tree structure.

The maximum extension without repeater is 100 m. Up to 2 repeaters are supported providing a maximum communication distance of 300 m. Terminating resistors are not needed.

Cable types

A special coded 2-wire cable is required. The modules are connected to the cable via penetration clamb connections while the coding ensures a reverse protection. A communication via screw clamb connectors is also possible as well as other unshielded cables can be used.

Data exchange

The AS interface supports the connection of conventional sensors and actors following the master-slave principle.

Administration

The I/O points of the slave devices are assigned electronically through the bus connection or the PLC program addressing the master within the network.

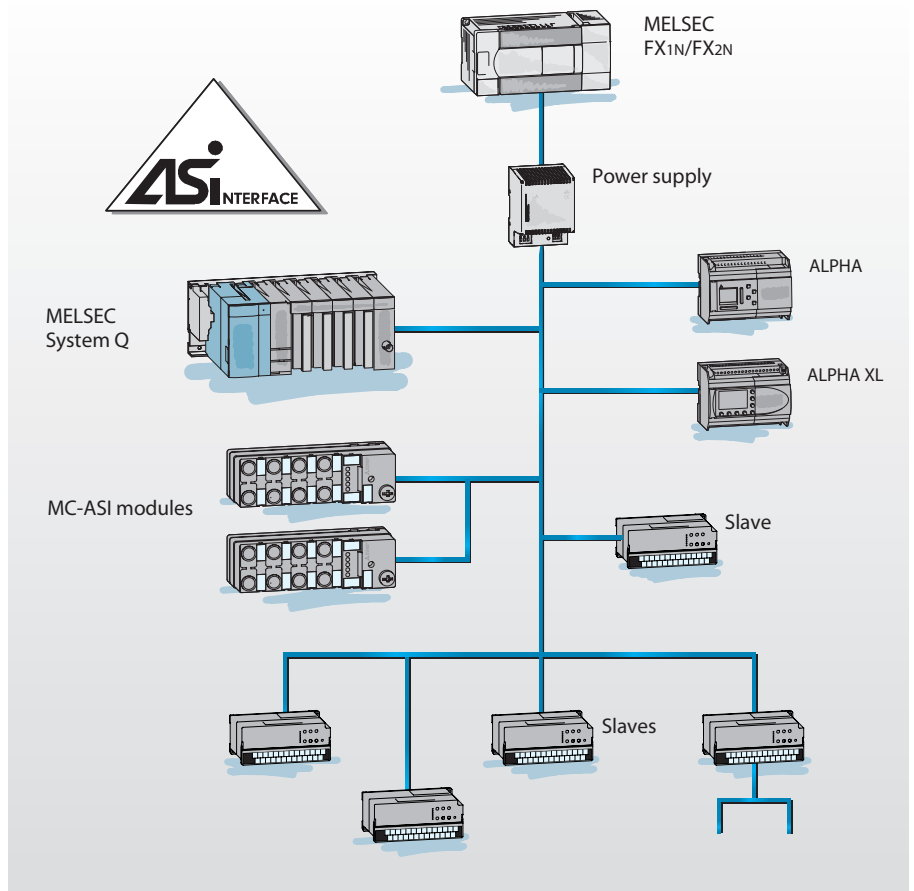

Specifications	AS interface
Network management	Master/slave
Cabling	Coded twisted-pair cable (unshielded)
Data transfer rate	kBit/s 167
Bus cycle time	≤5 ms
Max. overall distance	m 100 (300 with repeater)
Slave units per master	31
Repeaters per network	2

For further informations please refer to the technical catalogue for networks.

AS Interface Module AL□-ASI-BD

✓ ALPHA ✓ ALPHA XL

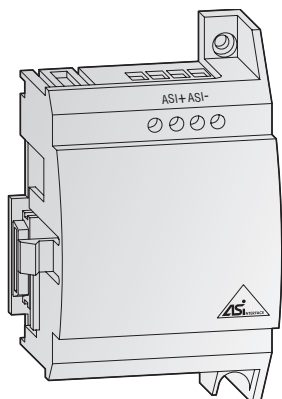

The Actuator Sensor Interface module AL□-ASI-BD in combination with an ALPHA controller facilitates the data communications via an AS interface system.

The AL-ASI-BD is plugged on the AL-20M□-□, the AL2-ASI-BD is plugged on an ALPHA XL series module and form a slave unit. Up to 4 inputs and 4 outputs can be exchanged with the ASI master.

The addresses of the slave devices in the ASI interface are assigned either automatically via the master in the network or via a programming device (software).

The maximum communication distance is 100 m without repeater. If 2 repeaters are used, the distance is extended to up to 300 m.

For the AS interface a separate power supply is required. The communication signal is superimposed on the power supply of the AS interface bus.

Specifications	AL-ASI-BD	AL2-ASI-BD
Applicable ALPHA controller	AL-20M□-□	ALPHA XL series
Module type	Slave module	
Number of I/O points	4 inputs, 4 outputs	
General operating conditions	Corresponding to ALPHA master controllers	
External power supply	30.5 V DC (AS interface power supply)	
External current consumption	mA	
	Max. 150	Max. 40
Communications protocol	ASI standard	
Transfer rate	167000 bit/s	
Communications method	APM (Alternating Pulse Modulation)	
Communications cable	ASI standard cable	
Communications distance	m	
	100 (300 with repeater)	
Max. data transfer per slave	4 read / 4 write; up to 31 slave modules	
I/O refresh	Max. 5 ms	
Number of modules per master	31	
Weight	kg	
	0.03	
Dimensions (W x H x D)	mm	
	61.5 x 90 x 26.5	53.1 x 90 x 24.5
Order information	Art. no.	
	124894	142525

Mounting of the ASI Module

Example shows ALPHA 20 and AL-ASI-BD

ALPHA controller

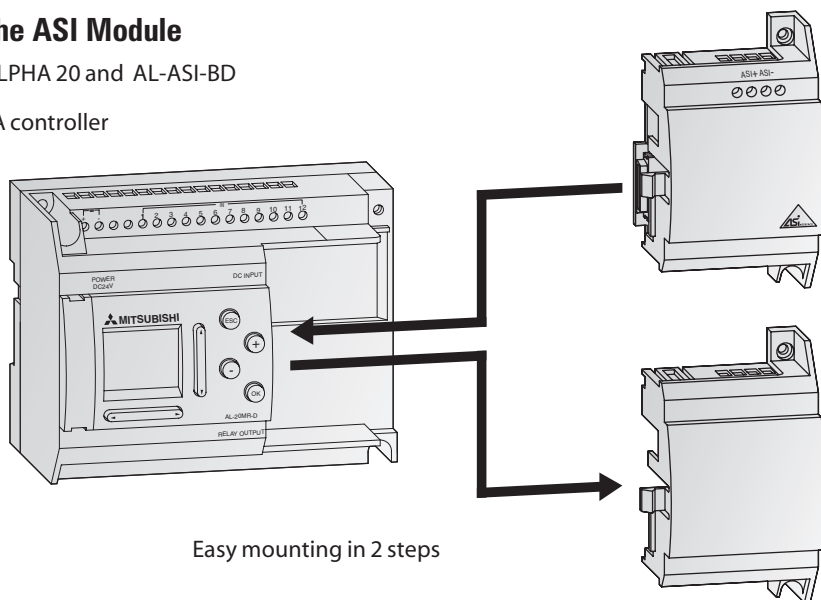

Remove module cover from the ALPHA 20.

Plug the AL-ASI-BD module on the ALPHA 20.

Easy mounting in 2 steps



Memory Cassettes AL-EEPROM

✓ ALPHA ✓ ALPHA XL

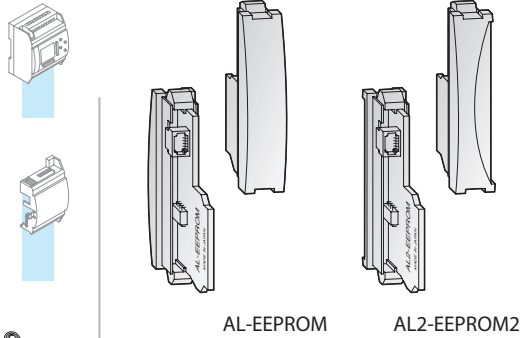

AL-EEPROM

AL2-EEPROM2

By means of the memory cassettes AL-EEPROM or AL2-EEPROM2 (for ALPHA XL series) a new program can be transferred to the internal system memory of the ALPHA controller or the program of the internal system memory can be saved on the external memory cassette.

If the memory cassette is used, a certain program can be run temporarily by simply plugging the external memory module.

After removing the memory cassette the former program in the internal memory is active again.

The memory cassette AL□-EEPROM□ is not a memory expansion but a medium for data exchange.

Data	AL-EEPROM	AL2-EEPROM2
Memory type	EEPROM	EEPROM
Application	ALPHA	ALPHA XL
Memory capacity	1.500 bytes	5.000 bytes
Function blocks	Max. 64	Max. 200
Dimensions (W x H x D) mm	10 x 45 x 25	10 x 45 x 25
Order information	Art. no. 87673	142526

IP40/IP54 Mounting Frames

✓ ALPHA ✓ ALPHA XL

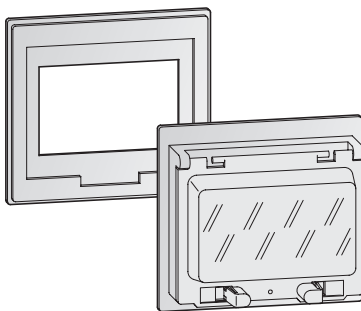

The ALPHA and ALPHA XL controllers can be built into control panels and the doors of control cabinets with the aid of special mounting frames. These mounting frames are available in the protection classes IP40 and IP54.

The IP54 frames are equipped with a flap allowing the function keys on the controller to be accessed when the flap is opened.

Data	AL-FRAME-6/10-IP40	AL-FRAME-6/10-IP54	AL-FRAME-20-IP40	AL-FRAME-20-IP54
Application	ALPHA		ALPHA XL	
Protection class	IP40	IP54	IP40	IP54
Design	Frame only	With transparent flap	Frame only	With transparent flap
Dimensions (W x H x D) mm	104 x 94 x 4	104 x 94 x 28	170 x 94 x 4	170 x 94 x 28
Order information	Art. no. 132332	132335	132333	132337

Simulation Box

✓ ALPHA ✓ ALPHA XL

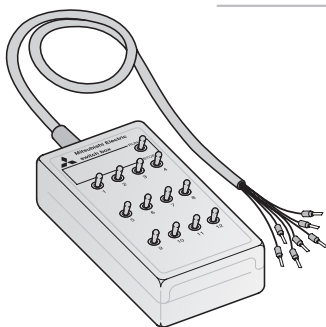

The simulation box provides 12 switches for simulating digital inputs.

The box can be used on all ALPHA controllers.

Data	Simulation box
Switches	12
Dimensions (W x H x D) mm	50 x 100 x 25
Order information	Art. no. 3386

■ Interface Cable AL-232CAB

✓ ALPHA ✓ ALPHA XL

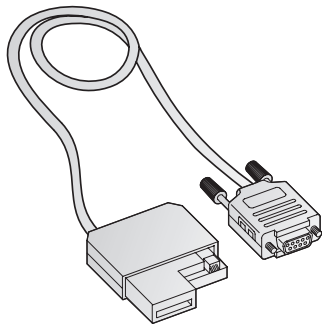

The AL-232CAB is an RS232C interface cable. It connects the ALPHA controller to a personal computer running the programming software for the ALPHA controller.

The cable ensures a galvanic isolation between the ALPHA controller and the personal computer. The cable AL-232CAB can not be used for any other connection.

Data		AL-232CAB
Application		ALPHA <-> PC
Length	m	2.5
Order information	Art. no.	87674

■ GSM Cable

□ ALPHA ✓ ALPHA XL

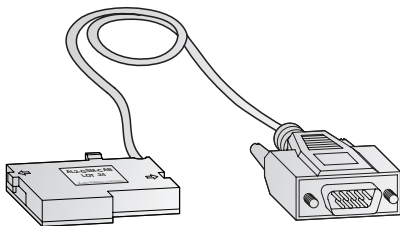

The GSM AL2-GSM-CAB is an RS232C interface cable and it is used to connect the ALPHA XL controller to a normal or GSM modem, a personal computer or other serial devices. It can transfer SMS data to a

GSM modem for onward transmission to mobile telephones or e-mail addresses. It also permits remote monitoring and remote maintenance.

Data		AL2-GSM-CAB
Connector		9-pin D-SUB connector
Application		ALPHA XL <-> PC, modem
Cable length	m	1.5
Order information	Art. no.	142528

■ 24 V Power Supply

✓ ALPHA ✓ ALPHA XL

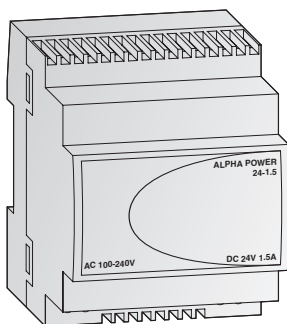

The Alpha Power is a convenient power supply for the 24 V units and other external devices. It comes with a DIN rail mounting system and its dimensions are matched to those of the ALPHA family.

Two Alpha Power units can be installed together for redundant mode operation or connected in parallel for more power. The units have an integrated thermal overload protection circuit.

Data		ALPHA POWER 24-1.5
Input voltage		100 – 240 V (45 – 65 Hz)
Output voltage		24 V DC (+/- 3 %)
Rated output current		1.5 A (temperature: 55 °C), 2.0 A (temperature: 40 °C)
Max. output current		2 A (110 V AC), 4 A (230 V AC)
Ambient temperature		-25 – +55 °C (operation), -40 – +85 °C (storage)
Ambient humidity		Max. 95 % relative humidity (non-condensing)
Weight	kg	0.2
Dimensions (W x H x D)	mm	71 x 90 x 57.8
Order information	Art. no.	149046

Terminal Assignment of the Master Controllers ALPHA



AL-6M□-□

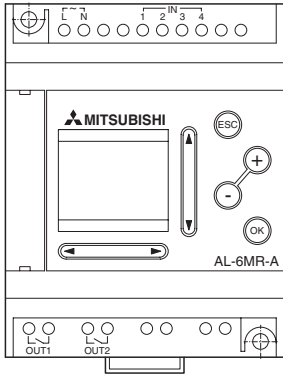

AL-10M□-□

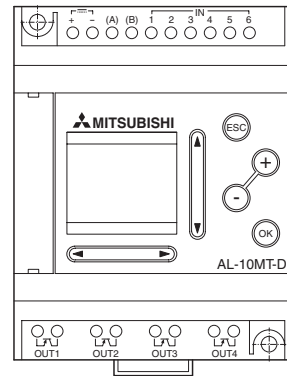
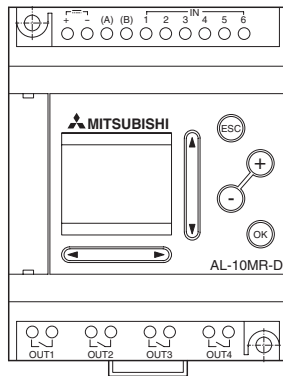
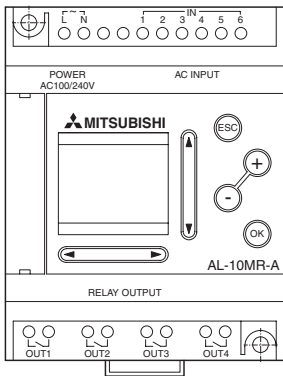

AL-20M□-□

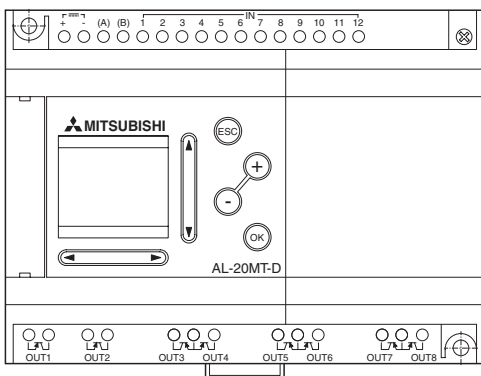
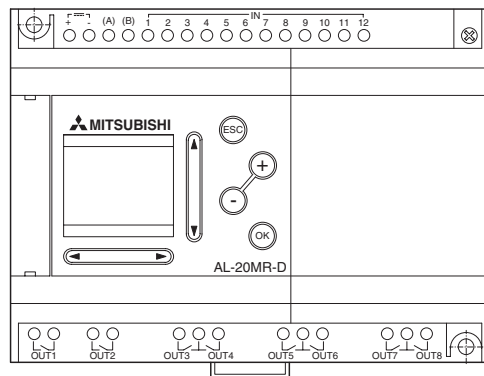
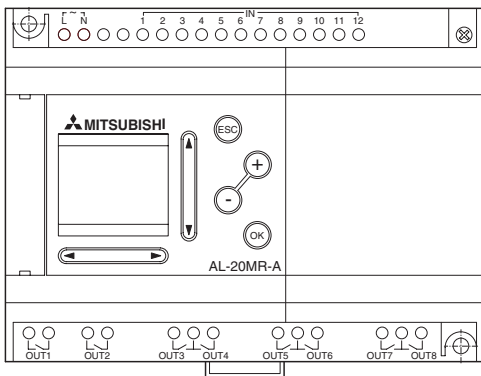

Terminal Assignment of the Master Controllers and Extension Modules ALPHA XL

AL2-14M□-□

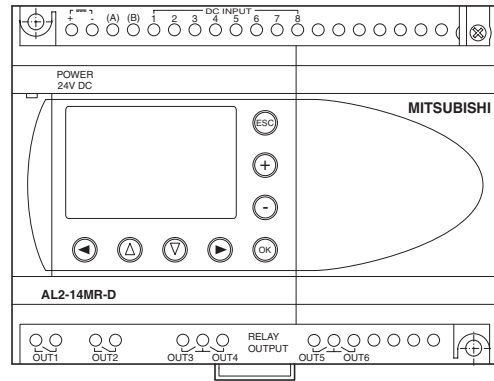
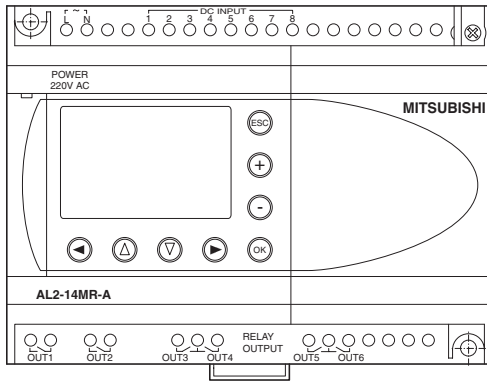

AL2-24M□-□

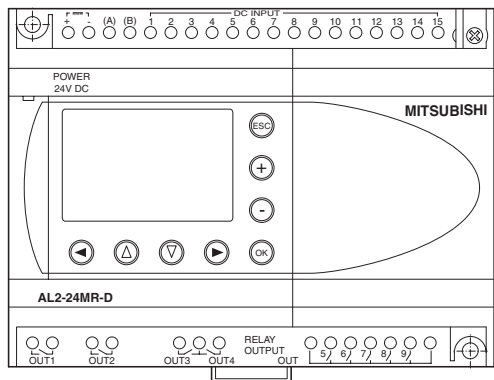
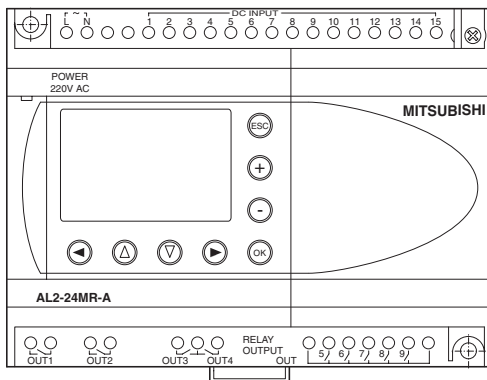

AL2-4EX

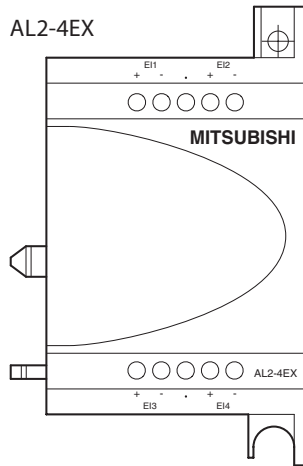

AL2-4EX-A2

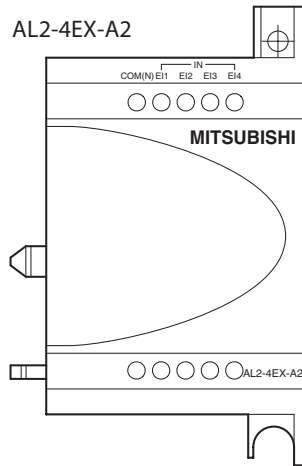

AL2-4EYT

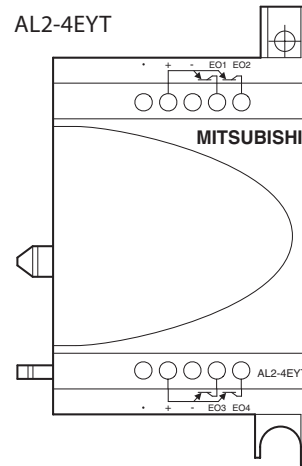

AL2-4EYR

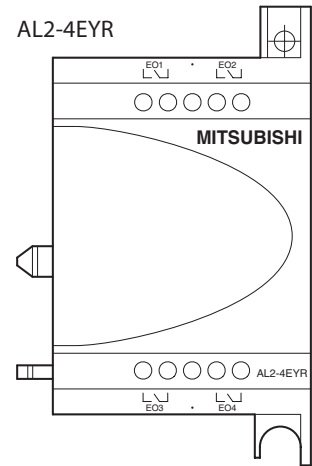

AL2-2DA

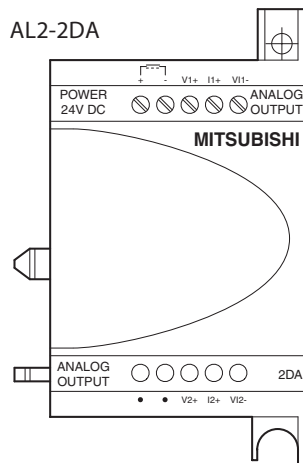

AL2-2PT-ADP

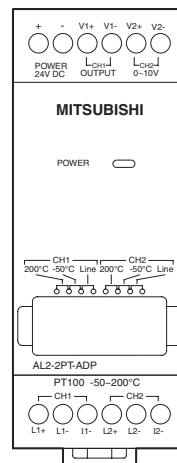

AL2-2TC-ADP

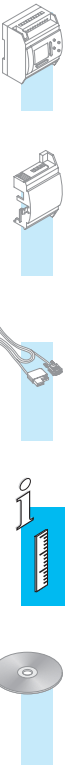
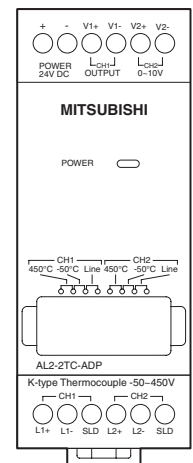

Dimensions of the Master Controllers

AL-6M□-□, AL-10M□-□

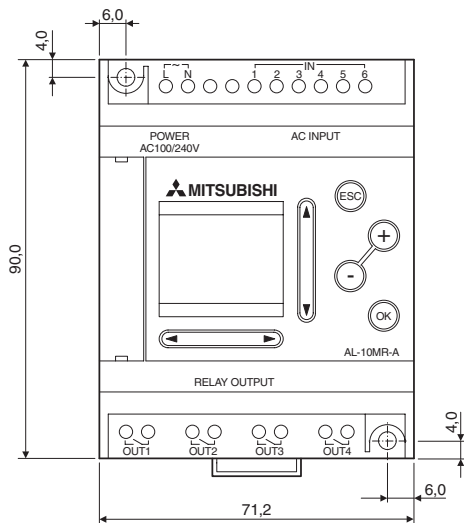
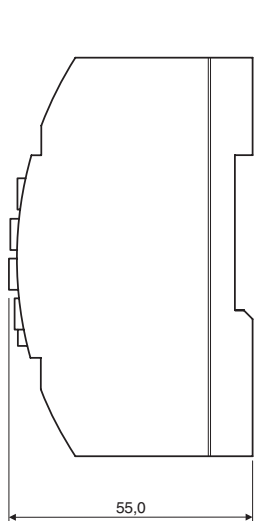

AL-20M□-□

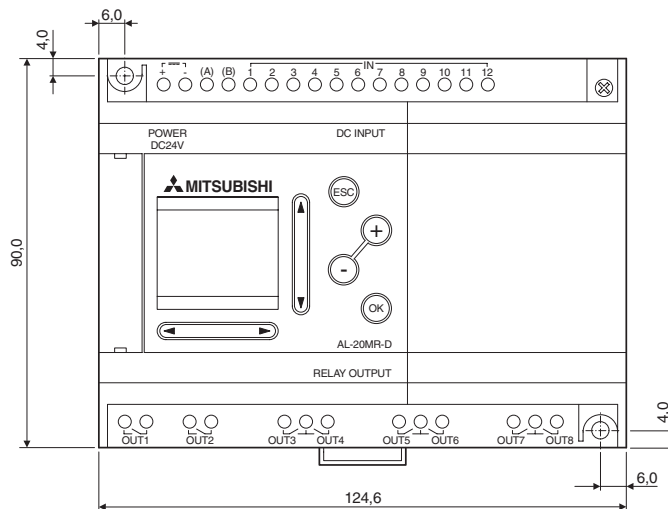
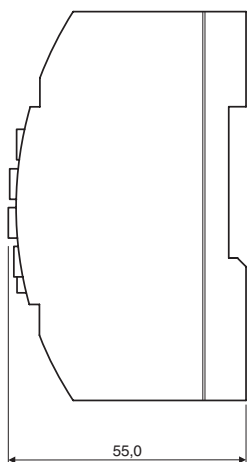

AL2-14M□-□, AL2-24M□-□

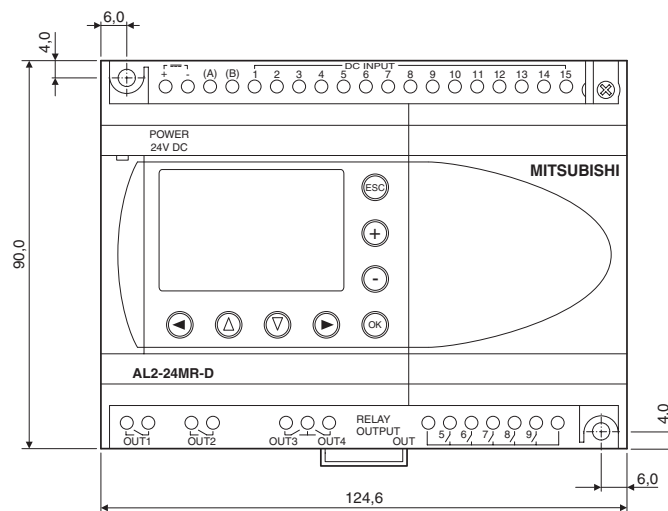
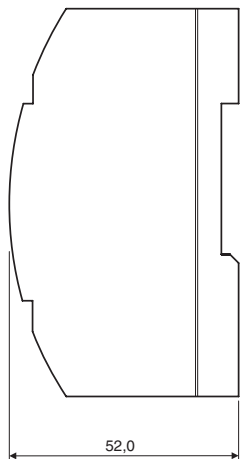

All dimensions in mm

Dimensions of the Extension Modules and ASI Modules

AL-4EX-□, AL2-4EY□, AL2-2DA

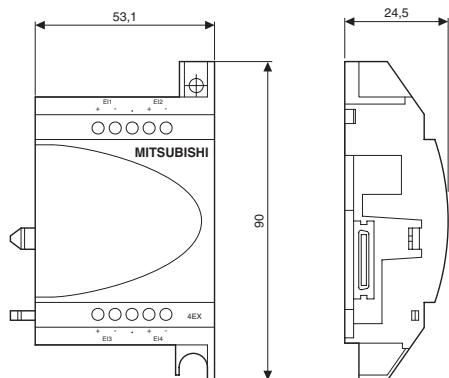

AL2-2PT-ADP, AL2-2TC-ADP

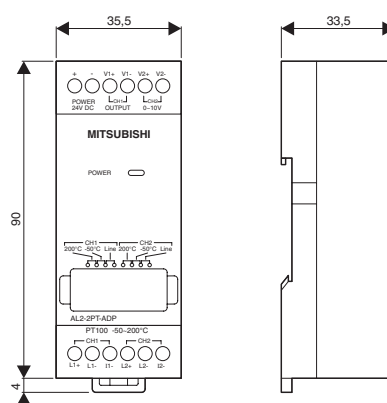

AL-ASI-BD

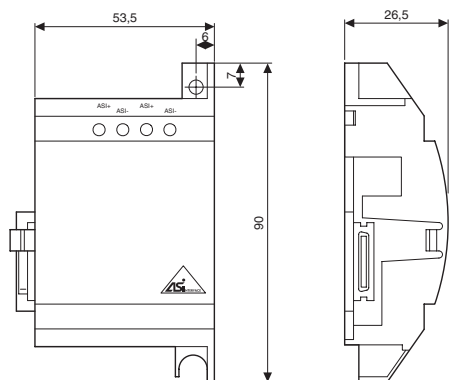

AL2-ASI-BD

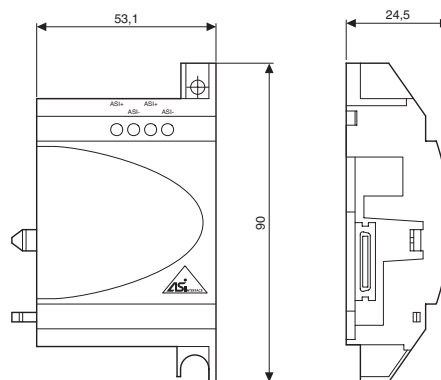

Mounting frame AL-FRAME

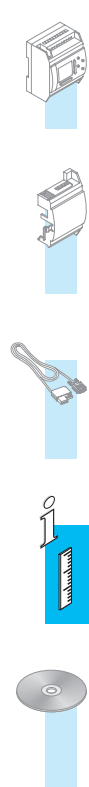
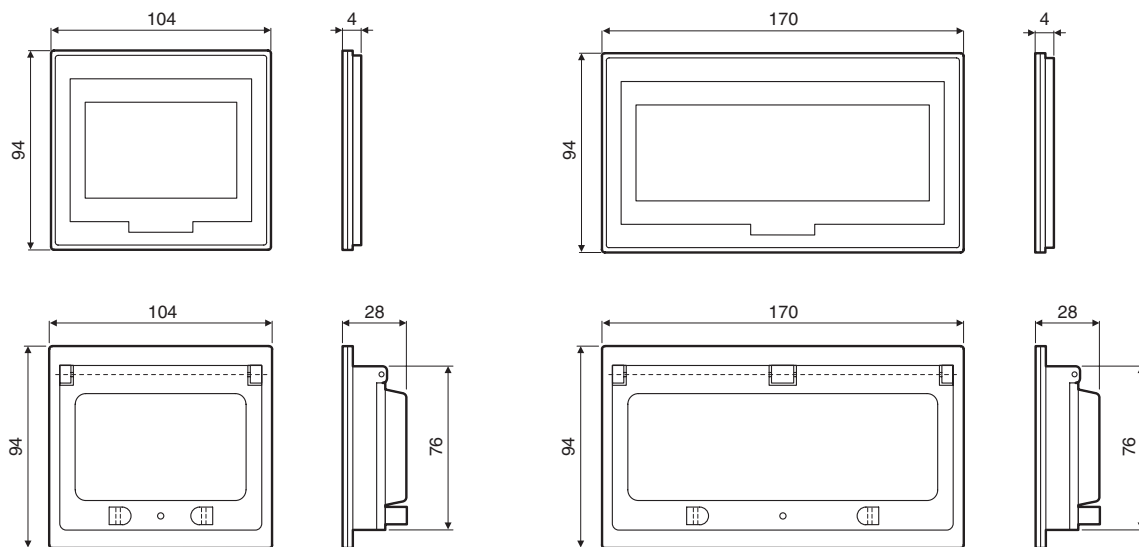

All dimensions in mm

Highly Efficient PC Programming Software AL-PCS/WIN

All controllers of the ALPHA series can be programmed with the MS Windows software AL-PCS/WIN. This software is very easy to use and requires no previous experience of the user.

The software can be installed in 6 different languages (D, GB, F, I, E) and also provides online help in the respective language.

Programming the ALPHA is very easy and is done by placing the different program elements on a graphical programming environment: The inputs on the left, the outputs on the right, and in between the different predefined function blocks (timers, counters, real-time clock, etc.). The connections (wiring) between the inputs, function blocks, and outputs are drawn graphically by mouse click to build the logic. By this, programs with up to 200 function blocks (ALPHA XL) can be created, where each single function in a program can be used as many times as desired. By means of a double-click on the respective function block the parameters of the function block are set (e.g. relay switching times, counter presets).

A complete documentation of the program can be created directly from AL-PCS/WIN.

Extent of delivery for AL-PCS/WIN

- CD-ROM with programming software AL-PCS/WIN (6 languages: D, F, GB, I, E, S)
- Product presentation of the ALPHA controller in different languages
- Complete documentation of the ALPHA controller in different languages (PDF files)
- Sample programs for all instructions of the ALPHA with comments in different languages
- Sample program with concrete program applications and comments in different languages.

DEMO version

The software is also available as an AL-PCS/WIN-DEMO version and can be downloaded at any time via the ALPHA homepage www.the-new-alpha.com. The DEMO version does, however, have the restriction that a written program cannot be transferred from the PC to the ALPHA controller, otherwise it has the same range of features.

The image displays the AL-PCS/WIN software interface. At the top, there are three tool bars: 'Tool bar inputs', 'Tool bar special inputs', and 'Tool bar outputs'. To the right, there are 'Function blocks' including logic gates (AND, OR, NOT, NAND, NOR), relays (RELAY), and timing elements (DELAY, PULSE, COUNTER, FLICKER, COMPARE). A 'Display manager for display control' is also shown. The main window shows a logic diagram for 'Illumination control for private house vis - (FBD)'. The diagram includes inputs like 'Hall-Light', 'Living Room', 'Outdoor', and 'Perm. OFF', and outputs like 'O 01' through 'O 06'. A 'Time Switch' and 'Alternate Relay' are also present. A 'User Func' button is visible on the left. Below the main window, there are three detailed tool bars for function blocks. A 'Delay' parameter dialog box is open, showing settings for 'OFF-Delay' and 'ON-Delay' with time units (10ms, 100ms, 1s).

Special Features of the Programming Software AL-PCS/WIN

Program simulation

A particular convenient advantage is the supported program simulation without a connected ALPHA controller. For this purpose the application program is simulated in the simulation module of the AL-PCS/WIN software.

By a mouse click, for example, inputs can be enabled and the status of the function blocks and the processes in the program are displayed graphically.

The simulation reduces the programming effort considerably - especially the programming of malfunctions is significantly minimized. A program can be tested locally separated from the hardware without endangering the hardware.

Monitor function

By means of the AL-PCS/WIN function "Monitor" the program execution can be monitored online on a PC (with connected ALPHA controller) under real conditions.

In this operation mode the real status of the inputs/outputs and function blocks is displayed during the program execution.

The monitoring function reduces programming times and the programming costs because failure diagnosis and debugging are speeded up significantly.

Process visualization

By means of the "System Sketch" window the AL-PCS/WIN software provides a simple process visualization as standard.



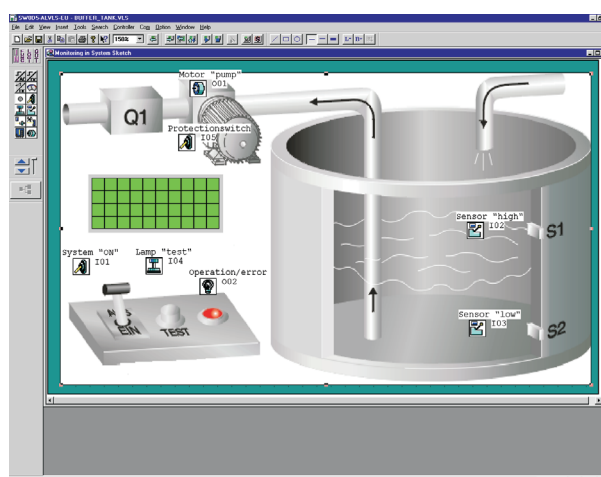
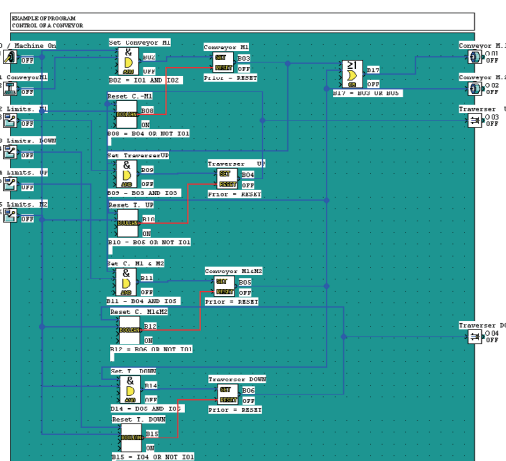
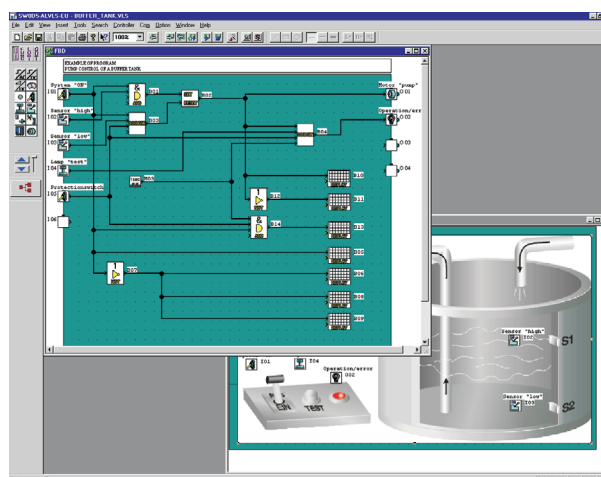





In a window separated from the programming environment graphical elements and elements from the program (inputs, outputs, function blocks, etc.) can be copied and configured. By this a graphical simulation and supervision of the program can be performed without accessing the programming environment. This enables an easy setup and maintenance of your application.









Data	AL-PCS/WIN-EU	AL-PCS/WIN-EU-DEMO
Version	Full featured version	Demo version (no communication with ALPHA controller)
Language	6 languages (German/English/French/Italian/Spanish/Swedish)	6 languages (German/English/French/Italian/Spanish/Swedish)
Extent of supply	CD-ROM including program and extensive documentation	CD-ROM including program and extensive documentation
Order information	Art. no. 152603	Available as download from www.the-new-alpha.com or from MELSOFT CD-ROM (139075)

Function Blocks of the Programming Software AL-PCS/WIN

Function	Symbol	Description	Function	Symbol	Description	Function	Symbol	Description
AND		AND connection with up to 4 signals, vacant inputs are processed as ON.	PULSE		Generates a pulse for one cycle at leading or trailing edge of an input signal.	COMPARE		Compares two values (less than, greater than, less than or equal, greater than or equal, not equal).
OR		OR connection with up to 4 signals, vacant inputs are processed as ON.	ALT		Alternating pulse relay (alternating self retaining ON/OFF status of the output).	OFFSET/GAIN		Increases signal (for analog value processing).
NOT		Inverts a signal. Outputs become ON, when inputs are OFF and vice versa.	ONE SHOT		One shot (Increases or decreases a pulse). Value range: 0.1 – 6553.5 s	DISPLAY		Displays messages or data on the LC display.
XOR		EXCLUSIVE OR connection with 2 signals	FLICKER		Symmetric or asymmetric pulse generator with defineable number of pulses and total length. Value range: 0.1 – 3276.7 s	ZONE COMPARE		Sets or resets an output, when a value is within a specified range. Value range: -32767 – 32767
NAND		NOT AND connection with up to 4 signals, vacant inputs are processed as OFF.	TIME SWITCH		Switches an output ON or OFF depending on date and time of the real-time clock (weekly or date programming).	SCHMITT TRIGGER		Sets output ON when reaching an upper limit value. Resets to OFF when reaching a lower limit value (or vice versa).
NOR		NOT OR connection with up to 4 signals, vacant inputs are processed as OFF.	TIME SWITCH M		Switches an output ON or OFF depending on a calendar or a given weekly schedule.	HOURLY METER		Running time meter counts hours and minutes; with output signal when exceeding the setting value. Value range: up to 32767 h and 59"
BOOLEAN		User programmable complex boolean connections with up to 4 signals, bracket notation and simulation option.	COUNTER		Up counter with count and RESET input; generates an output signal when the setting value is exceeded. Value range: 0 – 32767	SPEED DETECT		The signal input frequency is measured for a set length of time. The frequency is compared to a value range and the output is turned ON/OFF according to the result.
SET/RESET		Sets (ON) or resets (OFF) an output with priority detection.	UP/DOWN COUNTER		Up/down counter with 2 inputs and 2 reset inputs; output signal when exceeding the setting value. Value range: -32767 – 32767	PWM		A continuous pulse train is output. The pulse duty and the cycle time of the pulse can be defined.

Function	Symbol	Description
RETENTIVE ALTERNATE		Output alternates turning ON or OFF with each input pulse. The last output status is kept when the power supply is cycled OFF and ON.
ADDITION		Addition of the inputs A and B and output the result to Y.
SUBTRACTION		Subtraction of the inputs A and B and output the result to Y.
MULTIPLICATION		Multiplication of the inputs A and B and output the result to Y.
DIVISION		Division of the inputs A and B and output quotient Q and remainder R.
CALCULATION		Equation using different arithmetical functions and the selected data.
SHIFT		Shift operation. When the Shift signal is input the last signal status is output.
GSM SMS		The contents of an LCD screen is sent as an SMS message to a GSM phone number.

Function	Symbol	Description
RANDOM ONE SHOT		A random length single pulse is output to provide a random generator.
DELAYED ONE SHOT		After a set delay time, a single pulse is sent out.
DELAYED ALTERNATE		After a delay time, output alternates turning ON or OFF with each input pulse.
RETENTIVE SET/RESET		Latch a relay in SET or RESET position and give Set or Reset priority. The last output status is kept when the power supply is cycled OFF and ON.
DELAY		Delay a signal on the rising, falling or both edges. Value range: 0.1–6553.5 s
PID		PID control with auto tuning. To make a process value equal to a given set value, a manipulated value is processed and output.
AO (ANALOG OUTPUT)		A digital input value is processed and output as voltage or current signal via an analog extension module.



ORDER FORM

mitsubishi electric europe b.v. Industrial Automation / German Branch Gothaer Str. 8 D-40880 Ratingen Fax: +49 2102 486-7170	Company: Department: Street: Address: Phone: Fax:
-----------------------------------------------------------------------------------------------------------------------------------------------------	------------------------------------------------------------------------------------------------------

Order declaration

Pos.	Number	Item (type)	Article number	Description	Remarks

Notes when ordering:
When ordering, please use only the type designations and article numbers shown in this catalogue.

A		N	
Ambient temperature	10	Names of the parts	4
Analog extension	13	Network connection.	14
AS-Interface	14		
B		O	
Basic components	4	Operating conditions.	10
Base units	18	Order form.	26
C		P	
Communication	11	PC cable	17
Cabinet description	4	PC communication	11
D		Power supply	17
Differences between ALPHA <-> ALPHA XL	4	Programming	11
Digital extension	12	Programming specifications.	10
Dimensions		Programming software	22
Base units	20		
Extensions	21	R	
Mounting frame	21	Reference for model designation mode.	7
E		S	
Expansion capabilities	7	Simulation box	16
Extension modules.	12	Software	22
F		Specifications	
Features	4	AS-Interface module.	15
Function Blocks.	24	Base units	8
G		Analog extension.	13
GSM cable	17	Digital extension	14
GSM modem	11	Power supply	17
I		Memory cassettes	16
Interface cable	17	System specifications	10
L		T	
LC display	11	Temperature measurement	13
M		Terminal assignment	
Memory cassettes	16	Extensions	19
Module components	6	ALPHA base units	18
Mounting frame		ALPHA XL base units	19
Dimensions	21	W	
Specifications	16	Wiring.	11

HEADQUARTERS

MITSUBISHI ELECTRIC EUROPE B.V. **EUROPE**
German Branch
Gothaer Straße 8
D-40880 Ratingen
Phone: +49 (0) 2102 / 486-0
Fax: +49 (0) 2102 / 486-1120
e mail: megfamail@meg.mee.com

MITSUBISHI ELECTRIC EUROPE B.V. **FRANCE**
French Branch
25, Boulevard des Bouvets
F-92741 Nanterre Cedex
Phone: +33 1 55 68 55 68
Fax: +33 1 55 68 56 85
e mail: factoryautomation@fra.mee.com

MITSUBISHI ELECTRIC EUROPE B.V. **IRELAND**
Irish Branch
Westgate Business Park, Ballymount
IRL-Dublin 24
Phone: +353 (0) 1 / 419 88 00
Fax: +353 (0) 1 / 419 88 90
e mail: sales.info@meir.mee.com

MITSUBISHI ELECTRIC EUROPE B.V. **ITALY**
Italian Branch
Via Paracelso 12
I-20041 Agrate Brianza (MI)
Phone: +39 039 6053 1
Fax: +39 039 6053 312
e mail: factoryautomation@it.mee.com

MITSUBISHI ELECTRIC EUROPE B.V. **SPAIN**
Spanish Branch
Carretera de Rubí 76-80
E-08190 Sant Cugat del Vallés
Phone: +34 9 3 / 565 3131
Fax: +34 9 3 / 589 2948
e mail: industrial@sp.mee.com

MITSUBISHI ELECTRIC EUROPE B.V. **UK**
UK Branch
Travellers Lane
GB-Hatfield Herts. AL10 8 XB
Phone: +44 (0) 1707 / 27 61 00
Fax: +44 (0) 1707 / 27 86 95
e mail: automation@meuk.mee.com

MITSUBISHI ELECTRIC CORPORATION **JAPAN**
Office Tower "Z" 14 F
8-12,1 chome, Harumi Chuo-Ku
Tokyo 104-6212
Phone: +81 3 6221 6060
Fax: +81 3 6221 6075

MITSUBISHI ELECTRIC AUTOMATION **USA**
500 Corporate Woods Parkway
Vernon Hills, IL 60061
Phone: +1 847 / 478 21 00
Fax: +1 847 / 478 22 83

MIDDLE EAST REPRESENTATIVES

Ilan & Gavish Ltd. **ISRAEL**
Automation Service
24 Shenkar St., Kiryat Arie
IL-49001 Petah-Tiqva
Phone: +972 (0) 3 / 922 18 24
Fax: +972 (0) 3 / 924 07 61
e mail: iandg@internet-zahav.net

EUROPEAN REPRESENTATIVES

GEVA **AUSTRIA**
Wiener Straße 89
AT-2500 Baden
Phone: +43 (0) 2252 / 85 55 20
Fax: +43 (0) 2252 / 488 60
e mail: office@geva.at

TEHNIKON **BELARUS**
Oktjabrskaya 16/5, Ap 704
BY-220030 Minsk
Phone: +375 (0)17 / 210 4626
Fax: +375 (0)17 / 210 4626
e mail: tehnikon@belsonet.net

Getronics b.v. **BELGIUM**
Control Systems
Pontbeeklaan 43
BE-1731 Asse-Zellik
Phone: +32 (0) 2 / 467 17 51
Fax: +32 (0) 2 / 467 17 45
e mail: infoautomation@getronics.com

TELECON CO. **BULGARIA**
Andrej Ljapchev Lbv. Pb 21 4
BG-1756 Sofia
Phone: +359 (0) 2 / 97 44 05 8
Fax: +359 (0) 2 / 97 44 06 1
e mail: —

AutoCont **CZECH REPUBLIC**
Control Systems s.r.o.
Nemocnicni 12
CZ-702 00 Ostrava 2
Phone: +420 59 / 6152 111
Fax: +420 59 / 6152 562
e mail: consys@autocont.cz

Louis poulsen **DENMARK**
industri & automation
Geminivej 32
DK-2670 Greve
Phone: +45 (0) 70 / 10 15 35
Fax: +45 (0) 43 / 95 95 91
e mail: lpia@lpmail.com

UTU Elektrotehnika AS **ESTONIA**
Pärnu mnt.160i
EE-11317 Tallinn
Phone: +372 (0) 6 / 51 72 80
Fax: +372 (0) 6 / 51 72 88
e mail: utu@utu.ee

Beijer Electronics OY **FINLAND**
Ansatie 6a
FIN-01740 Vantaa
Phone: +358 (0) 9 / 886 77 500
Fax: +358 (0) 9 / 886 77 555
e mail: info@beijer.fi

UTECO A.B.E.E. **GREECE**
5, Mavrogenous Str.
GR-18542 Piraeus
Phone: +302 (0) 10 / 42 10 050
Fax: +302 (0) 10 / 42 12 033
e mail: sales@uteco.gr

Meltrade Automatika Kft. **HUNGARY**
55, Harmat St.
HU-1105 Budapest
Phone: +36 (0)1 / 2605 602
Fax: +36 (0)1 / 2605 602
e mail: office@meltrade.hu

SIA POWEL **LATVIA**
Lienes iela 28
LV-1009 Riga
Phone: +371 784 / 22 80
Fax: +371 784 / 22 81
e mail: utu@utu.lv

UAB UTU POWEL **LITHUANIA**
Savanoriu pr. 187
LT-2053 Vilnius
Phone: +370 (0) 52323-101
Fax: +370 (0) 52322-980
e mail: powel@utu.lt

EUROPEAN REPRESENTATIVES

INTEHSIS SRL **MOLDOVA**
Cuza-Voda 36/1-81
MD-2061 Chisinau
Phone: +373 (0)2 / 562 263
Fax: +373 (0)2 / 562 263
e mail: intehsis@mdl.net

Getronics b.v. **NETHERLANDS**
Control Systems
Donauweg 2 B
NL-1043 AJ Amsterdam
Phone: +31 (0) 20 / 587 67 00
Fax: +31 (0) 20 / 587 68 39
e mail: info.gia@getronics.com

Beijer Electronics A/S **NORWAY**
Teglverksveien 1
N-3002 Drammen
Phone: +47 (0) 32 / 24 30 00
Fax: +47 (0) 32 / 84 85 77
e mail: info@beijer.no

MPL Technology Sp. z o.o. **POLAND**
ul. Sliczna 36
PL-31-444 Kraków
Phone: +48 (0) 12 / 632 28 85
Fax: +48 (0) 12 / 632 47 82
e mail: krakow@mpl.pl

Sirius Trading & Services srl **ROMANIA**
Str. Biharia No. 67-77
RO-013981 Bucuresti 1
Phone: +40 (0) 21 / 201 1146
Fax: +40 (0) 21 / 201 1148
e mail: sirius@siriustrading.ro

INEA SR d.o.o. **SERBIA AND MONTENEGRO**
Karadjordjeva 12/260
SCG-113000 Smederevo
Phone: +381 (0)26/ 617 - 163
Fax: +381 (0)26/ 617 - 163
e mail: inea_sr@verat.net

AutoCont Control s.r.o. **SLOVAKIA**
Radlinského 47
SK-02601 Dolný Kubín
Phone: +421 435868 210
Fax: +421 435868 210
e mail: info@autocontcontrol.sk

INEA d.o.o. **SLOVENIA**
Stegne 11
SI-1000 Ljubljana
Phone: +386 (0) 1-513 8100
Fax: +386 (0) 1-513 8170
e mail: inea@inea.si

Beijer Electronics AB **SWEDEN**
Box 426
S-20124 Malmö
Phone: +46 (0) 40 / 35 86 00
Fax: +46 (0) 40 / 35 86 02
e mail: info@beijer.se

ECONOTEC AG **SWITZERLAND**
Postfach 282
CH-8309 Nürensdorf
Phone: +41 (0) 1 / 838 48 11
Fax: +41 (0) 1 / 838 48 12
e mail: info@econotec.ch

GTS **TURKEY**
Darülaceze Cad. No. 43 Kat. 2
TR-80270 Okmeydani-Istanbul
Phone: +90 (0) 212 / 320 1640
Fax: +90 (0) 212 / 320 1649
e mail: gts@turk.net

CSC Automation Ltd. **UKRAINE**
15, M. Raskova St., Fl. 10, Office 1010
UA-02002 Kiev
Phone: +380 (0) 44 / 494 3355
Fax: +380 (0) 44 / 494 3366
e mail: csc-a@csc-a.kiev.ua

EURASIAN REPRESENTATIVES

Avtomatika Sever Ltd. **RUSSIA**
Lva Tolstogo Str. 7, Off. 311
RU-197376 St Petersburg
Phone: +7 812 1183 238
Fax: +7 812 1183 239
e mail: as@avtsev.spb.ru

Consys **RUSSIA**
Promyshlennaya St. 42
RU-198099 St Petersburg
Phone: +7 812 325 3653
Fax: +7 812 147 2055
e mail: consys@consys.spb.ru

Electrotechnical **RUSSIA**
Systems Siberia
Shetinkina St. 33, Office 116
RU-630088 Novosibirsk
Phone: +7 3832 / 119598
Fax: +7 3832 / 119598
e mail: info@eltechsystems.ru

Elektrostyle **RUSSIA**
Poslannikov Per., 9, Str.1
RU-197005 Moscow
Phone: +7 095 542 4323
Fax: +7 095 956 7526
e mail: info@estl.ru

Elektrostyle **RUSSIA**
Krasnij Prospekt 220-1, Office No. 312
RU-630049 Novosibirsk
Phone: +7 3832 / 106618
Fax: +7 3832 / 106626
e mail: info@estl.ru

ICOS **RUSSIA**
Industrial Computer Systems Zao
Ryazanskij Prospekt, 8A, Off. 100
RU-109428 Moscow
Phone: +7 095 232 0207
Fax: +7 095 232 0327
e mail: mail@icos.ru

NPP Uralelektra **RUSSIA**
Sverdlova 11A
RU-620027 Ekaterinburg
Phone: +7 34 32 / 532745
Fax: +7 34 32 / 532745
e mail: elektra@etel.ru

STC Drive Technique **RUSSIA**
Poslannikov Per., 9, Str.1
RU-107005 Moscow
Phone: +7 095 790 7210
Fax: +7 095 790 7212
e mail: info@privod.ru

AFRICAN REPRESENTATIVE

CBI Ltd. **SOUTH AFRICA**
Private Bag 2016
ZA-1600 Isando
Phone: +27 (0) 11/ 928 2000
Fax: +27 (0) 11/ 392 2354
e mail: cbi@cbi.co.za